



Eco-friendly specification

Reducing usage of lubrication oil



U.S. PATENTED

C-Lube Linear Way ML	Linear Way L
No. 7677804 7252435 6729761 6712511	No. 7258486 6517244 6176617 6082899 5967667
C-Lube Linear Way MLV	Linear Way E
No. 8465206	No. 7677804 6176617 5967667
C-Lube Linear Way MV	Linear Way H
No. 6712511 6729761	No. 7677804 6082899 6176617 5967667 6461045 5622433 6250805 6176617
C-Lube Linear Way ME	Linear Way F
No. 7748905 7677804 6729761 6712511	No. 6176617 5967667
C-Lube Linear Way MH	Linear Way U
No. 7832929 6712511 7762723 7748905 7677804 6729761	No. 6880975 6176617 6851857 6082899 6517244 5967667 6461045 5967667 6309107
C-Lube Linear Way MUL	
No. 5435649	
C-Lube Linear Roller Way Super MX	
No. 8403563 7950852 8403562 7927016 8123408 7862234 8113714 7832930 8033730 7997800	No. 8585288 7458721 8506166 7458720 8206036 5800064 8113714 7780356 7534042
Linear Roller Way Super X	
No. 7832930 6766897 7458721 6461045 7458720 6176617	No. 7341378 5622433 5967667 5464288 5800064

Eco-friendly

Consumption of precious oil resource is minimized! And elimination of oil feeder and its piping reduces the initial cost!

Contributes to reduction of total cost and environmental loads!!

Oil usage reduction effect

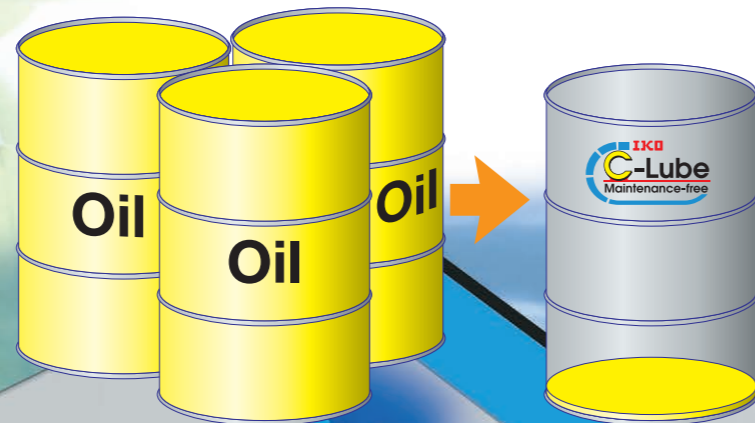

Maintenance free

Endures running over 20,000 km without oil feeding!

Troublesome lubrication maintenance process is reduced!!

Distance equivalent to halfway around the globe

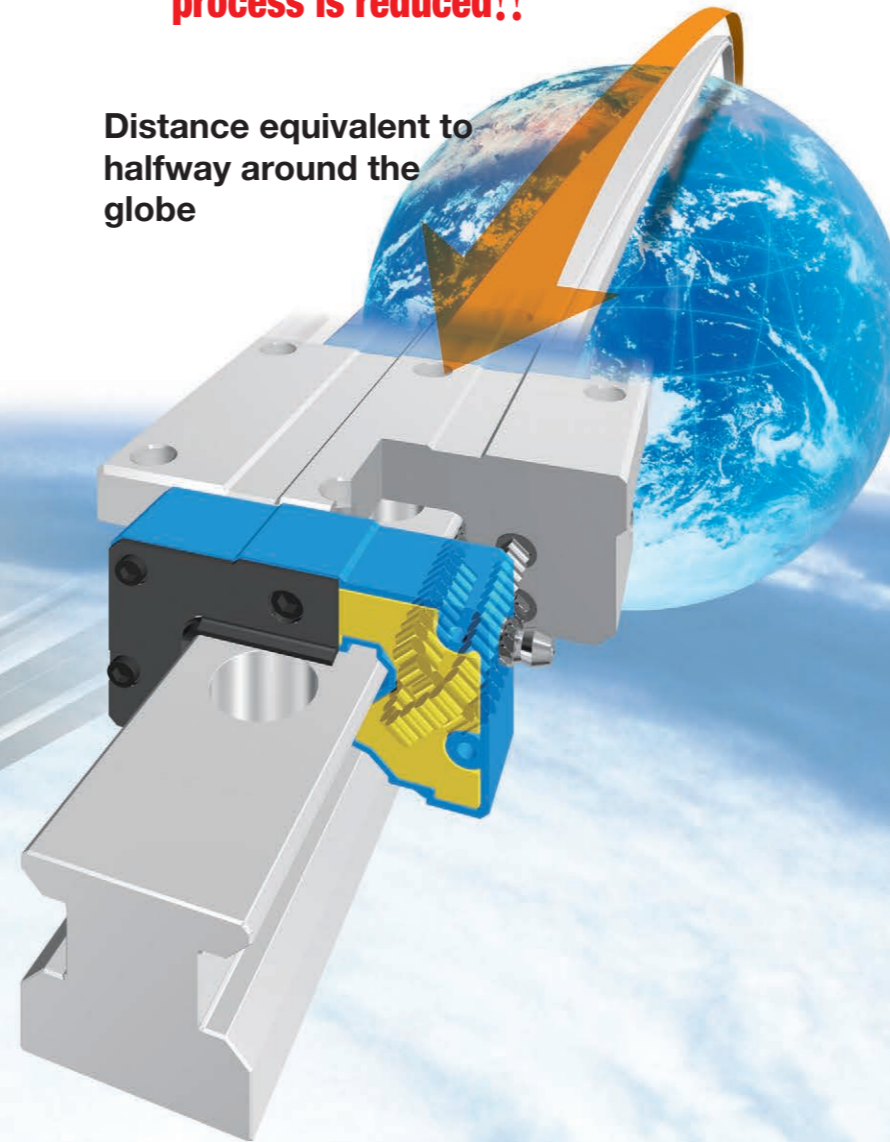

Compactness

The space consuming oil feeder is eliminated to save the space!

Freedom of machine designing is expanded for user!!

Efficient use of space

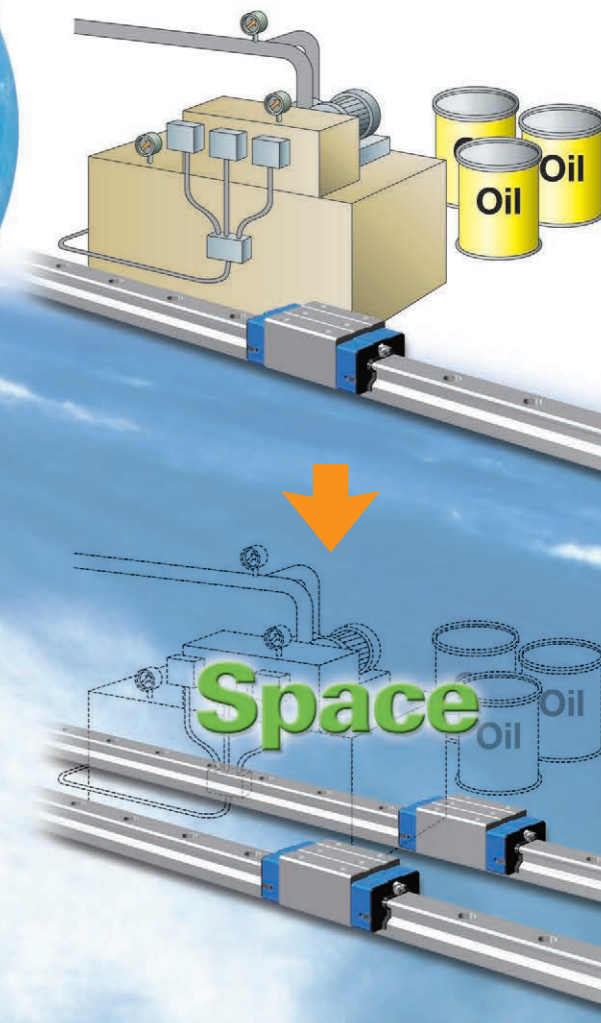



Features of C-Lube Linear Way and C-Lube Linear Roller Way

Original and world's first structure with [C-Lube]

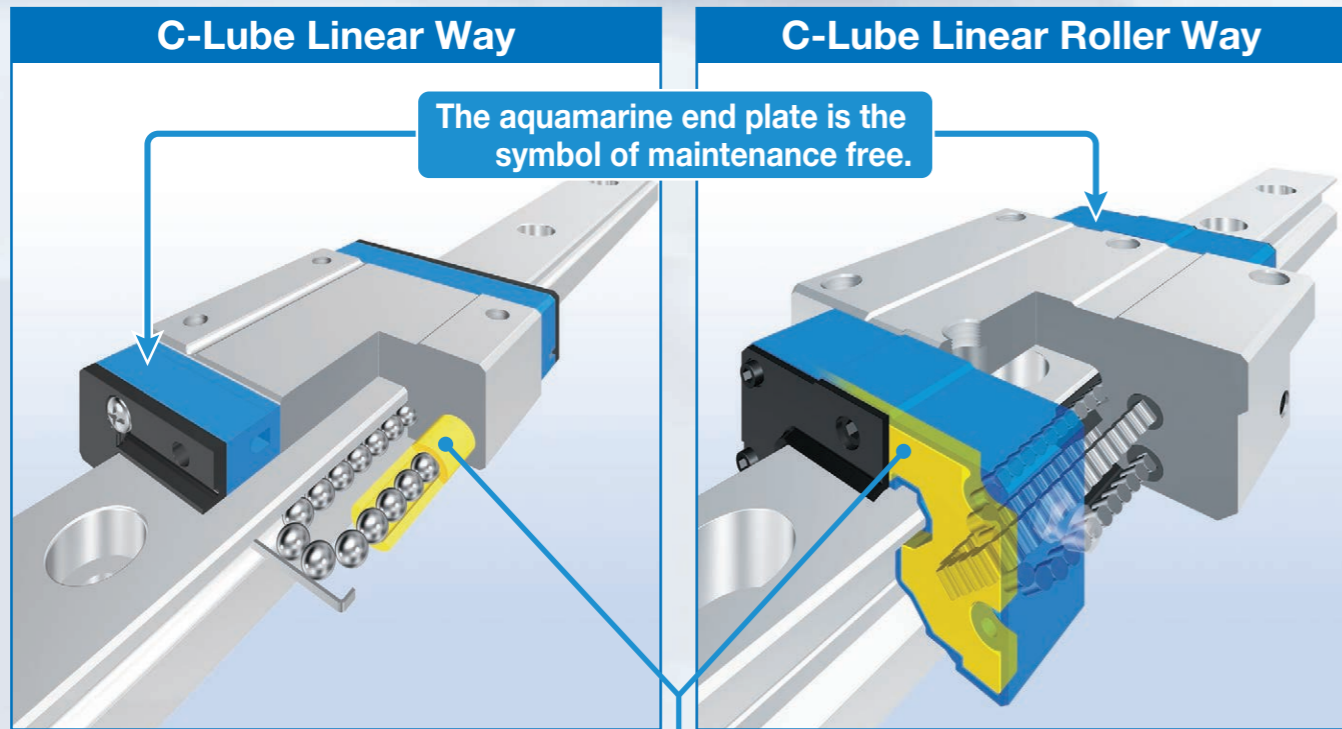

C-Lube integrated

Lubrication oil is carried through circulation of rolling elements

The lubrication oil is supplied directly to the rolling elements, not to the track rail. When rolling elements make contact with the capillary lubricating element integrated with the circulation path of slide unit rolling elements, the lubrication oil is supplied to surfaces of rolling elements and carried to the loading area through circulation of rolling elements. This results in adequate lubrication oil being properly maintained in the loading area and lubrication performance will last for a long time.

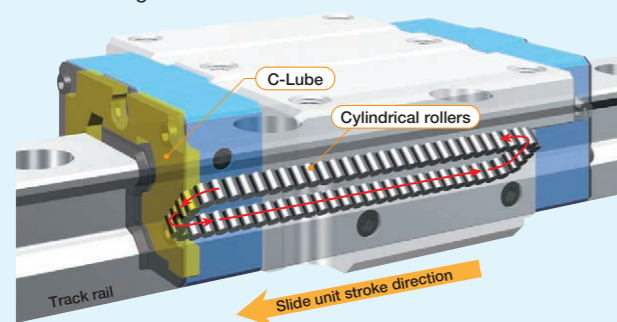

Lubrication oil is directly supplied to surfaces of the rolling elements

The surface of capillary lubricating element is always covered with the lubrication oil. Lubrication oil is continuously supplied to the surface of rolling elements by surface tension in the contact of capillary lubricating element surface and rolling elements. On the surface of capillary lubricating element with which the rolling elements make contact, new lubrication oil is always supplied from the other sections.

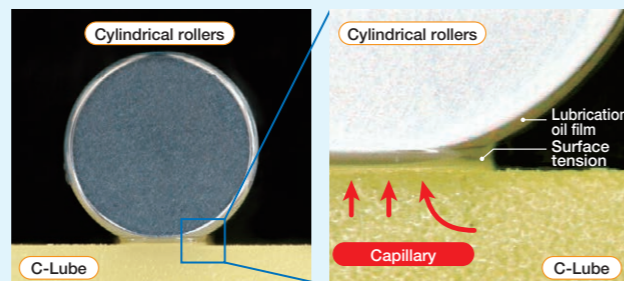

Long term maintenance free is realized with oil impregnated with C-Lube only !!



Maintenance free

This endures running over 20,000 km without oil feeding with lubrication oil in the C-Lube only. Furthermore, grease is pre-packed in the slide unit so long term maintenance free can be realized.

Maintenance free is achieved until the end of device life!

*1. Typical device life is assumed. Re-greasing may be necessary depending on use conditions.

Durability test result

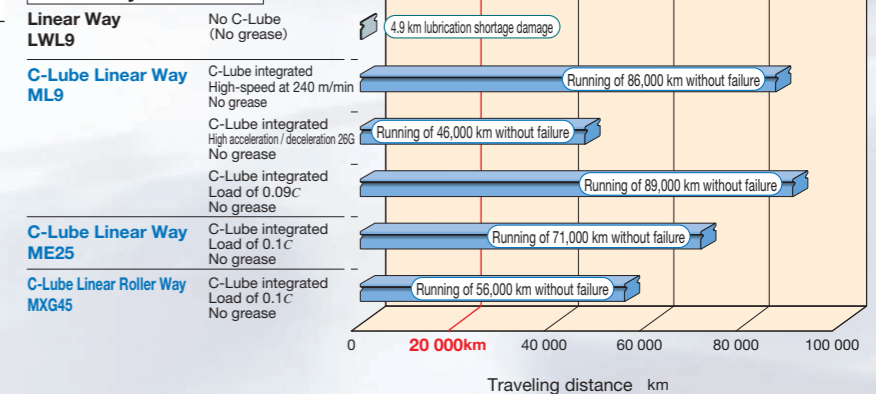

Eco-friendly

As lubrication oil in C-Lube is supplied by the amount necessary to maintain lubrication performance of the rolling guide, the consumption of lubrication oil is reduced and lubrication performance is maintained even when it run for a long period.

Eco-friendly specification reducing usage of lubrication oil!

Oil supply test result

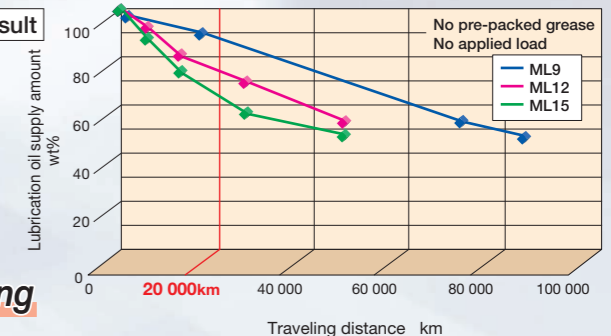

Compact

As C-Lube Linear Way and C-Lube Linear Roller Way are integrated with lubrication part C-Lube, their slide units are not long unlike types with external lubrication parts. Replacement of conventional parts is easy free from constraints of mounting space and stroke length.

Compact design taking into account compactness!

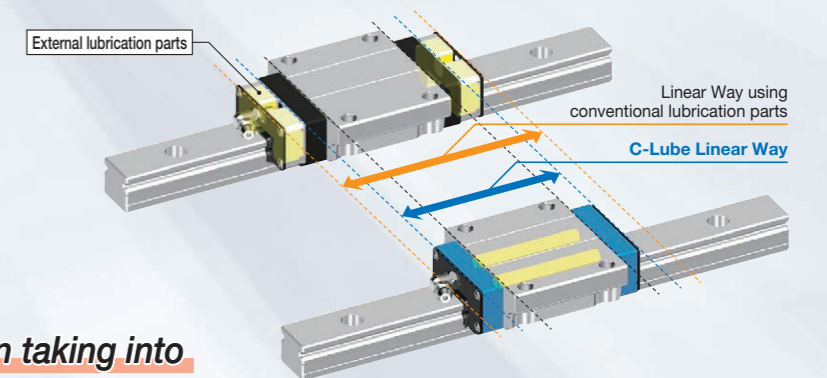

Smooth

C-Lube Linear Way and C-Lube Linear Roller Way do not generate slide resistance unlike lubrication parts external to the slide unit that make contact with the track rail. Driving force follow-up property is superior and energy is saved by improvement of accuracy and reduction of friction loss.

Light and smooth motion is achieved!

Frictional resistance test result

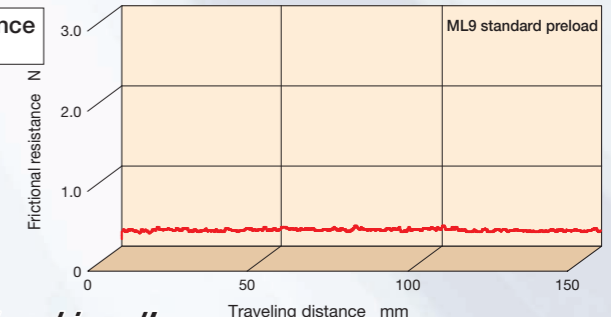

Ultimate **Interchangeable** pursuit of elimination

system by radical of any waste

Accuracy interchangeability

Three accuracy classes are available!
Height variation can be controlled with multiple assembled sets!

High accuracy of the device can be maintained in the multiple-use environment!!

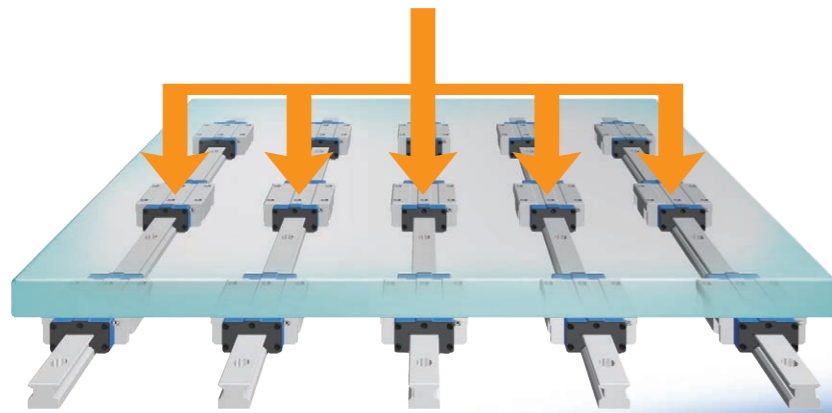

Unit interchangeability

Many type of slide units are available!
Every slide unit is interchangeable with the same track rail!

It is easily added or replaced!!

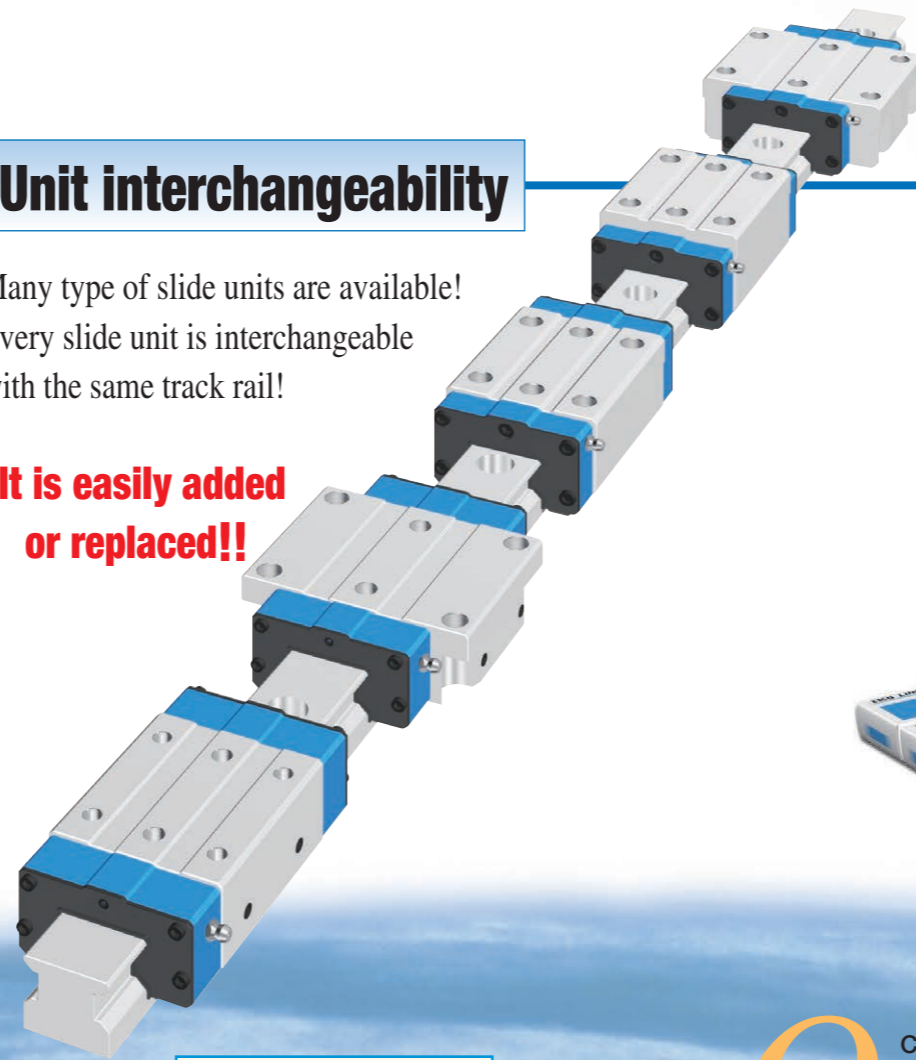

Short delivery products

Separate delivery of slide unit and track rail!

You may order what you need by any quantity at any time!!

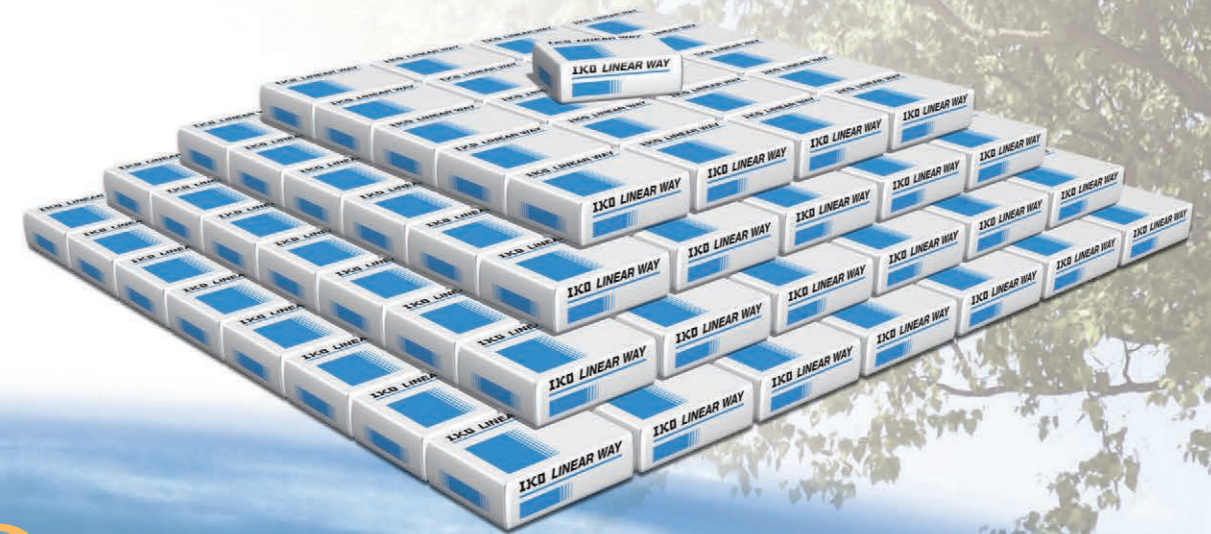

Q I dropped the Linear Way unit by mistake, and the unit is damaged. Can I replace it?

Oh, dear! It's going to be late

A **Unit interchangeability**
If you use Linear Way of Interchangeable specification, you may need to replace only slide unit.

Sounds great!

Q Calculated accuracy cannot be achieved after assembly of the device?

Accuracy not improved

Please modify my accuracy

A **Accuracy interchangeability, preload interchangeability**
How do you like to use accuracy higher by one class or higher preload type?
As accuracy of the interchangeable products is controlled strictly by parts, setting can be modified.

Fine accuracy

Q I need to increase the rigidity of the unit because of sudden specification change.

Need more rigidity

I want to be long type...

A **Unit interchangeability**
The rigidity can be improved easily by increasing the unit length.

Power up

Q I carelessly forgot to arrange some parts, but I need them urgently. Can it be delivered soon?

I forgot to arrange

If late...

A **Short delivery available**
Interchangeable parts are available for short delivery, they can be delivered quickly with our perfect inventory system.
Slide unit and track rail can be ordered individually.

Sounds great!

Free combination is enabled for model, accuracy, preload!!

Ultimate interchangeable system

Interchangeable specification

Requirements of ;

- Wish to improve the rigidity and life of machines
- Wish to improve the accuracy of machines
- Wish to replace the slide unit immediately
- The number of slide units is in short
- Wish to replace the track rail immediately
- The length of track rail is not sufficient
- Wish to store only the slide units in stock for emergency

Interchangeable specification realizes ;

- Wish to prepare for a sudden design change
- Wish to select freely the combination of high accuracy and preload
- Slide unit and track rail are separately handled
- Free combination of slide unit and track rail can be selected
- Compactness-independent storing of slide units and track rails

Select the products as many as you wish.

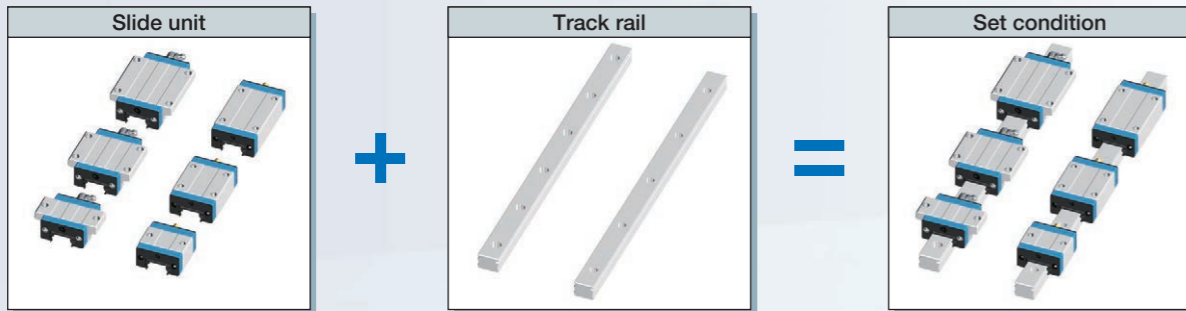

Unit interchangeability

A wide variety of slide unit models with different sectional shape and length are provided, for free replacement on the same track rail.

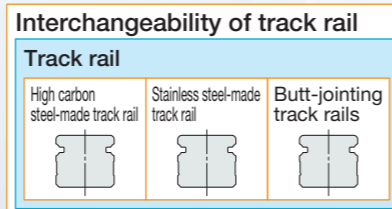

Interchangeability of slide unit

Slide unit shape

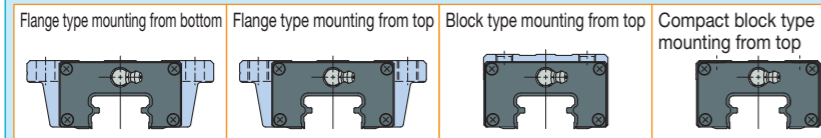

Length of slide unit

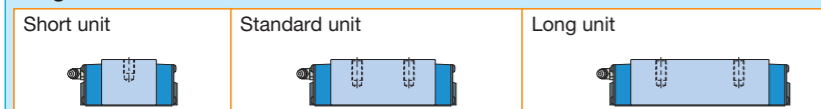

Free selection is possible for slide units and track rails!

Interchangeable specification has realized the incomparable high interchangeability by severely managing the dimensions of slide unit and track rail with the background of unique high processing technology.

This feature allows independent handling of slide unit and track rail, thus allowing you to select free combination and to order any products for any volume at any necessary time.

Accuracy interchangeability

Three accuracy classes of Ordinary, High and Precision class are provided, to support even high traveling accuracy purposes. In addition, as height variation of multiple assembled sets is managed with high accuracy, you may use parallel track rails at ease.

Standard setting up to precision

- Tolerances of dimensions H and N
- Variation of dimensions H and N in 1 set
- Parallelism in operation of the C surface to A surface
- Parallelism in operation of the D surface to B surface

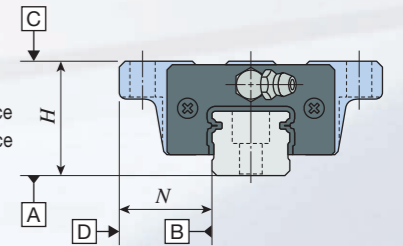

It allows the accuracy improvement of units without design changes!

Corresponding to parallel arrangement of multiple assembled sets as standard

- Variation of dimensions H of multiple assembled sets is specified

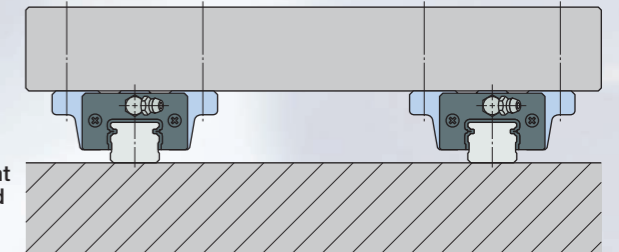

Preload interchangeability

The high accuracy dimensions management utilizing the simple structure achieved the interchangeability of preloaded slide units. It supports the applications requiring the rigidity of one higher rank.

High preload setting is possible thanks to high accuracy dimensions control

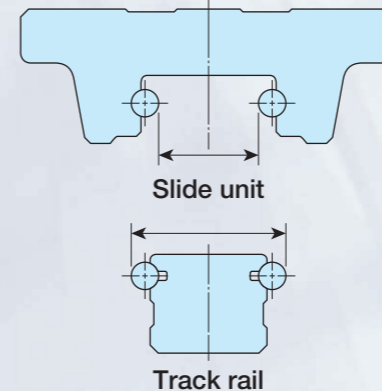

Light preload

Takeover

Standard preload

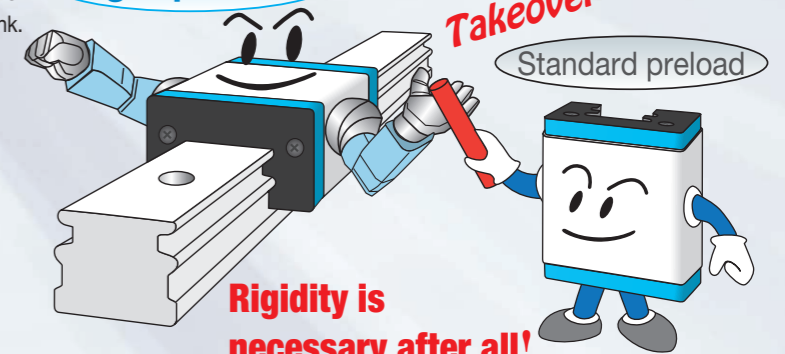

Rigidity is necessary after all!

It allows the rigidity improvement of units without design changes!

Maintenance free is achieved only by replacing the slide unit!

By replacing the interchangeable Linear Way or Linear Roller Way slide unit with C-Lube Linear Way or C-Lube Linear Roller Way slide unit, maintenance free is achieved while using the same track rail.

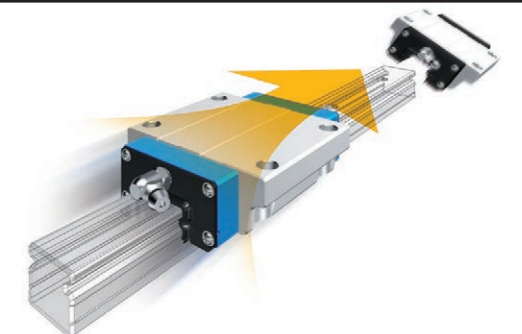

IKO's excellent features realized by contact in two-row raceways

a simple structure by **four-points**

Two-row four-point contact type simple structure

IKO adopts two-row four-point contact type for every Linear Way series. Thanks to our design know how and production technologies having been fostered for long time, high accuracy and smooth motion are realized in the micro series.

In addition, load in every direction can be received evenly and therefore stable high accuracy and rigidity can be achieved even in applications where load has variable direction and size or complex load is applied.

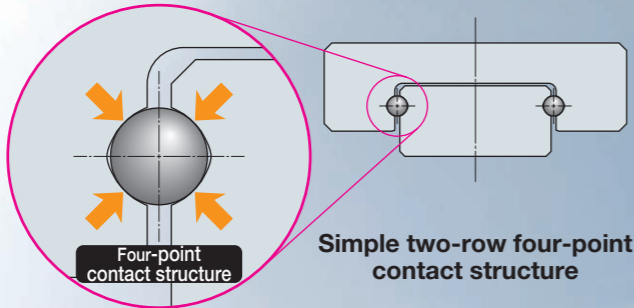

Essential for micro sizing!

Micro Linear Way L realized by simple structure

Micro Linear Way L for further needs of miniaturization produced by original small sizing technology. Wide variety of track rail width from 1 mm to 6 mm is available and high accuracy of micro positioning mechanism is realized.

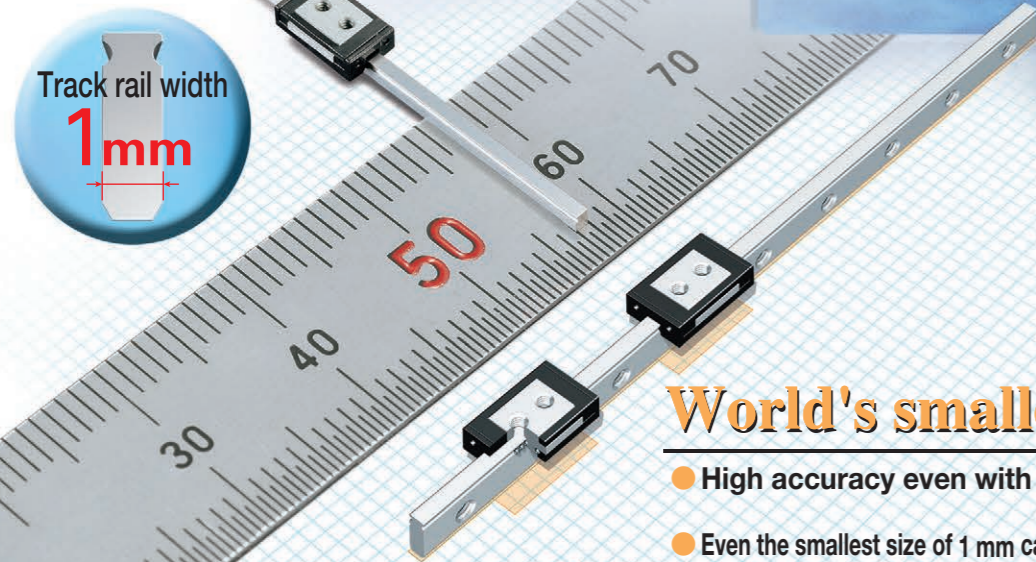

World's smallest size!

- High accuracy even with the smallest size of 1 mm*!
*Track rail width of 1 mm
- Even the smallest size of 1 mm can be securely mounted and fixed**!
**Tapped rail specification
- Even the smallest size of 1 mm can ensure stable operation!

IKO Micro Linear Way L

LWL1

LWL1 can be used for further super miniaturization of machines and devices with free-minded thinking.

Interchangeable

The simple structure of four-contact in two-row raceway yields small manufacturing errors or accuracy measurement errors, allowing the maintenance of each raceway in the high dimensions accuracy.

This technology realizes interchangeable specification and high interchangeable system in every series!

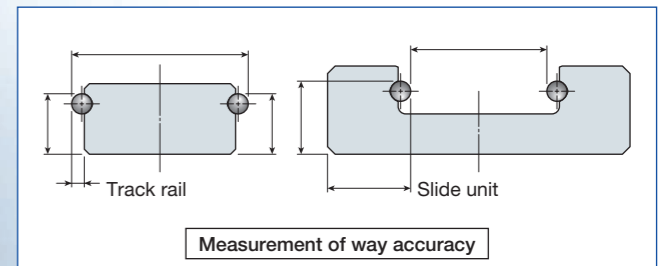

As the ball is stabilized during track groove measurement, measurement of high accuracy and precise pre-load management are possible.

Variety of models and size variations

A wide variety of models and sizes, such as super miniature size of only 1 mm track rail width, is provided for your selection to meet each requirement.

Series	Model	Size	Track rail width	
			Min	Max
C-Lube Linear Way ML	ML	20 models	15 sizes	3 ~ 42 mm
	LWL	22 models	19 sizes	1 ~ 42 mm
C-Lube Linear Way MLV	MLV	1 model	3 sizes	7 ~ 12 mm
C-Lube Linear Way MV	MV	1 model	3 sizes	20 ~ 30 mm
C-Lube Linear Way ME	ME	18 models	6 sizes	15 ~ 45 mm
	LWE	21 models	6 sizes	15 ~ 45 mm
C-Lube Linear Way MH	MH	17 models	9 sizes	8 ~ 45 mm
	LWH	19 models	11 sizes	8 ~ 65 mm
Linear Way F	LWF	4 models	7 sizes	33 ~ 90 mm
C-Lube Linear Way MUL	MUL	1 model	2 sizes	25 ~ 30 mm
	LWU	1 model	4 sizes	40 ~ 86 mm



Ultimate high performance produced by world's

first roller guide structure of IKO

Super high load capacity

The Linear Roller Way Super X has a large contact area with the way and a number of cylindrical rollers with excellent load capacity, which allows to achieve larger load rating.

Comparison of basic dynamic load rating

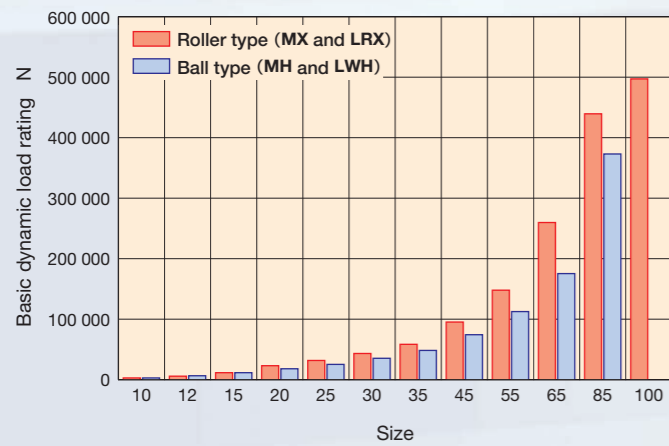

Comparison of basic static load rating

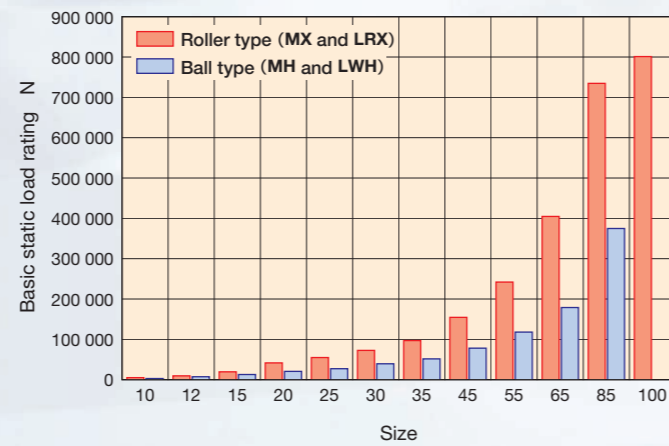

Size smaller by one size than the ball type can be used!

Long life

《Roller Type》MXG45

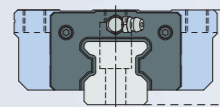

$C = 124\,000\text{ N}$
 $C_0 = 223\,000\text{ N}$

《Ball Type》MHG45

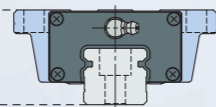

$C = 95\,200\text{ N}$
 $C_0 = 114\,000\text{ N}$

Same size

C : Basic dynamic load rating N
 C_0 : Basic static load rating N
 L : Life km
 P : Applied load N

Roller type has large basic dynamic load rating C and long life due to the different "index"!

[Life calculation example]

Roller Type

$$L = 50 \left(\frac{C}{P} \right)^{10/3}$$

Applied load
In case of 10000 N

$$L \approx 220\,000\text{ km}$$

Ball Type

$$L = 50 \left(\frac{C}{P} \right)^3$$

$$L \approx 43\,000\text{ km}$$

Significant increase!

Super high rigidity

The rigidity of linear motion rolling guide significantly affects properties of machines and devices to be incorporated.

The Linear Roller Way Super X achieves high rigidity as a number of small cylindrical rollers with smaller elastic deformation relative to load than that of balls are incorporated in the slide unit.

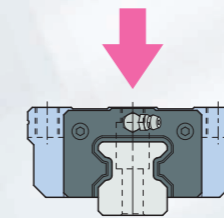
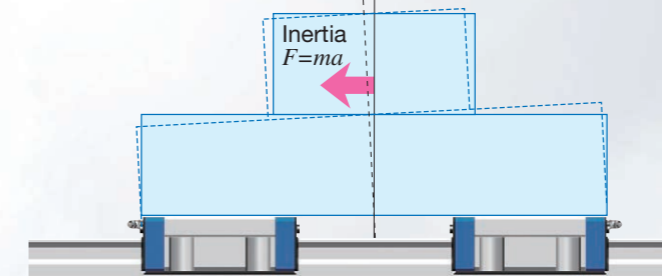

Comparison of elastic deformation

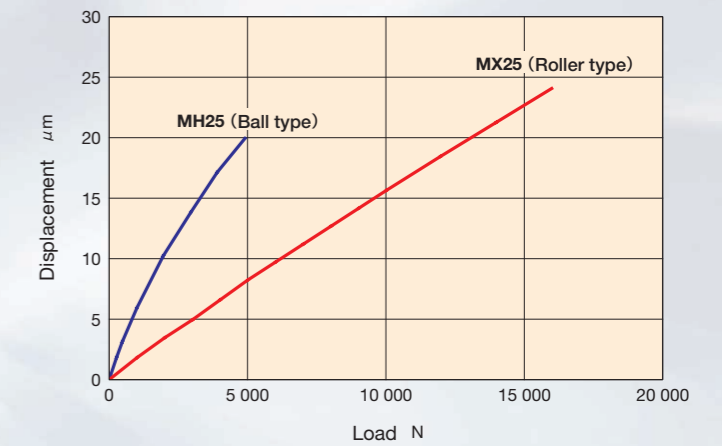

Well-balanced high rigidity is realized in every direction!

Vibration characteristics

The Linear Roller Way Super X has high rigidity relative to ball types of the same size, so deformation amount is low relative to repeated fluctuating load, natural frequency is high and vibration damping time is short.

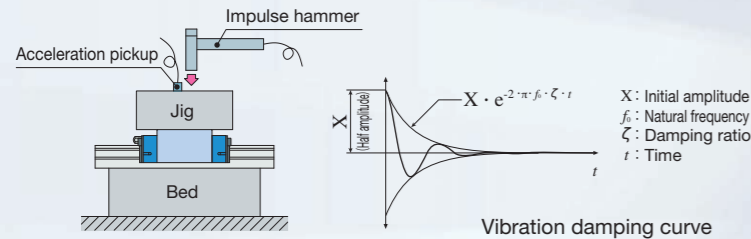

Vibration damping curve in downward vibration (Half amplitude)

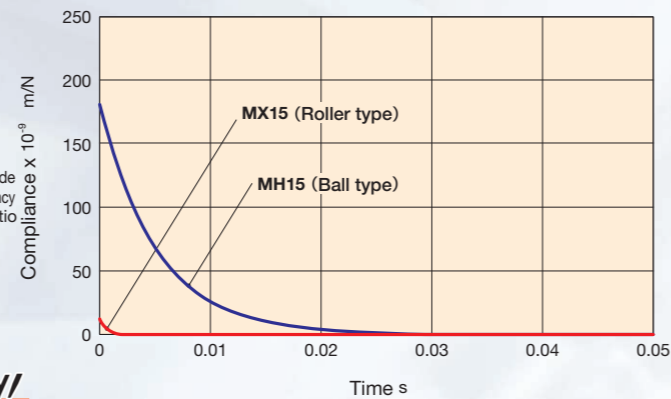

Positioning time can be shortened!

Allows accurate positioning with excellent frictional characteristic

The Linear Roller Way Super X prevents skew of cylindrical roller and achieves smooth motion by adopting unique retaining method to accurately guide cylindrical roller ends with retaining plate.

The Linear Roller Way Super X has good response characteristics to micro-feeding and allows for accurate positioning, thanks to small frictional resistance against preload and load and excellent frictional characteristics relative to plain guides and ball type linear motion rolling guide.

MXDL25 and MXDG45 T₃ preload frictional resistance

Test portion	Extra long unit MXDL25 Long unit MXDG45
Preload	T ₃ preload
Velocity	0.6 m/min
Lubrication	C-Lube integrated, with grease

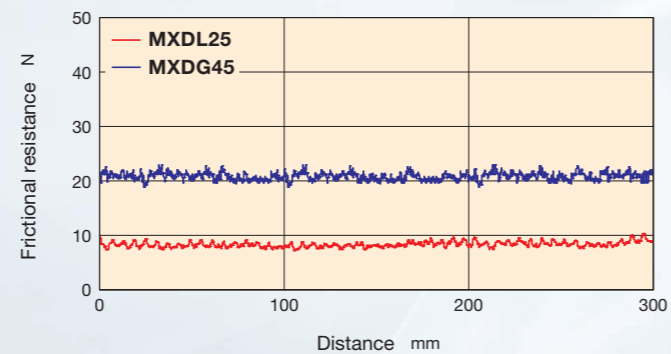

High follow-up property is ensured even for micro-feeding!

High running accuracy

Optimal design based on analysis of re-circulation behavior of cylindrical roller circulation realizes smooth and quiet motion. In addition, load is applied to many cylindrical rollers and therefore the micro deflection during running is minimized. Extra long unit is optimal for applications requiring higher running accuracy. (For details, see page I -29)

Deflection amount during running

unit: μ m

MXDG30 T ₃ preload	0.12
-------------------------------	------

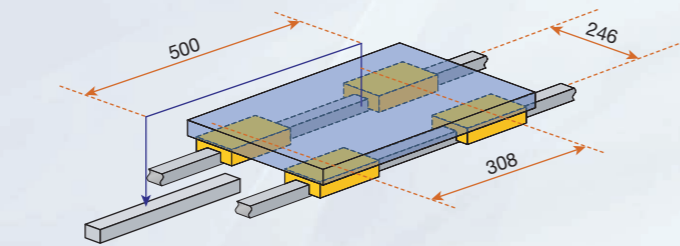

Stable running accuracy is achieved!

Corresponding to compactification

Roller type with significantly higher load capacity than the ball type. The Linear Roller Way Super X allows for downsizing from many size variations for compactification of devices.

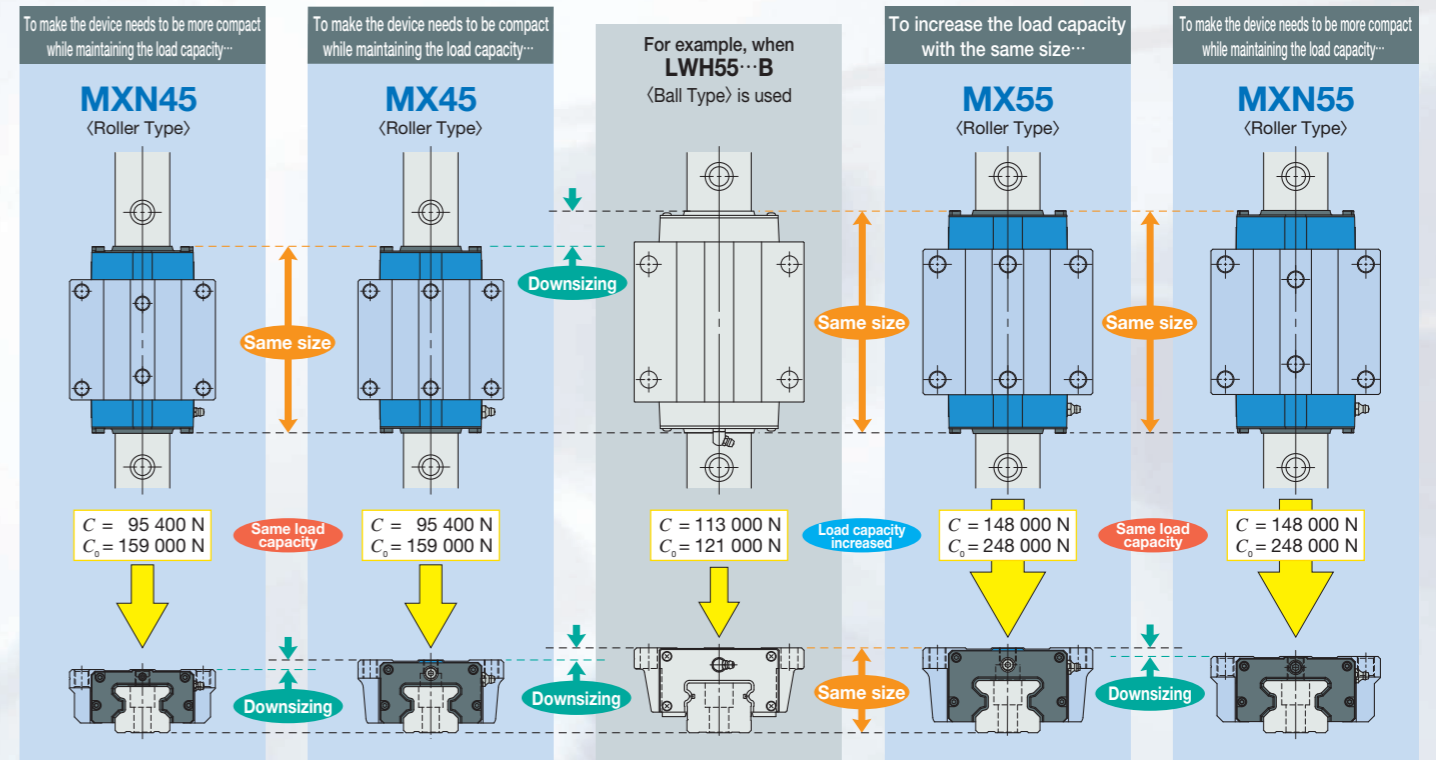

Downsizing and increased load capacity!

Roller type with large increase of load capacity!

Compatible ball type and mounting dimensions

The Linear Roller Way Super X has mounting dimensions compatible with the ball type Linear Way H. Replacement with roller type is possible without significant design change to machine or device.

《Roller Type》 C-Lube Linear Roller Way Super MX	《Ball Type》 C-Lube Linear Way MH
---	--

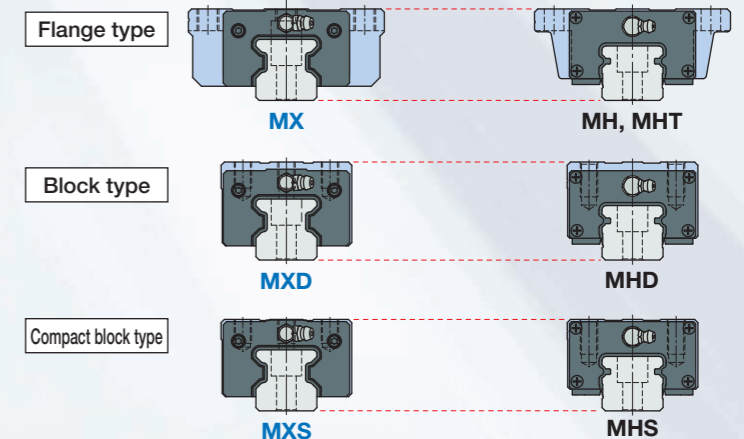

Downsizing and increased load capacity are possible!

A variety of models and size variations

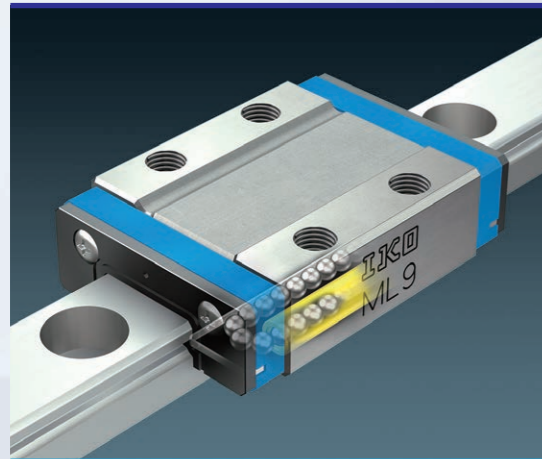

Ball Type Miniature Series

C-Lube Linear Way ML C-Lube Linear Way MLV Linear Way L

Thanks to the structure with two rows of balls to contact with the way at four points, stable accuracy and rigidity can be achieved even in applications where load has variable direction and size or complex load is applied, despite its very small body.



Micro Linear Way L

As the lineup of track rail width from 1 mm to 6 mm is available, you can select an optimal product for the specifications of your machine and device. For LWL1, world's smallest size is realized: track rail width of 1 mm, slide unit width of 4 mm and assembly height of 2.5 mm.

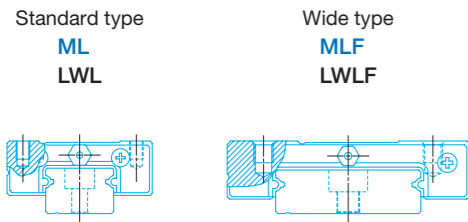

Length of slide unit		Size	
C	Short	Standard type	1, 2, 3, 5, 7, 9, 12, 15, 20, 25
No symbol	Standard	Wide type	2, 4, 6, 10, 14, 18, 24, 30, 42
G	Long		
L	Extra long		

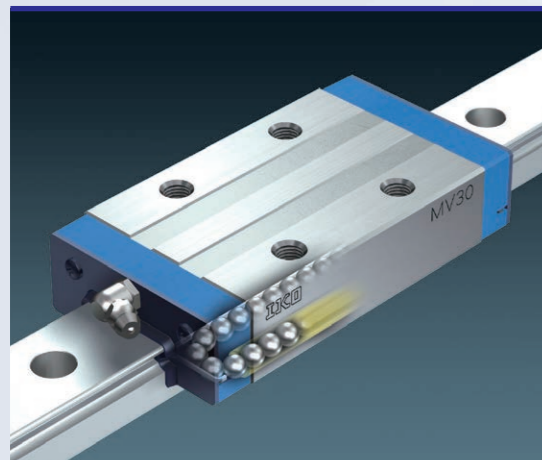

Ball Type Low Profile/Light Weight Series

C-Lube Linear Way MV

Despite its extra low profile and extra light weight, this linear motion rolling guide has the maximum load rating among the ball types while achieving high load capacity.

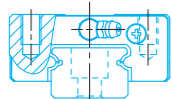

Length of slide unit	Size
Standard	20, 25, 30

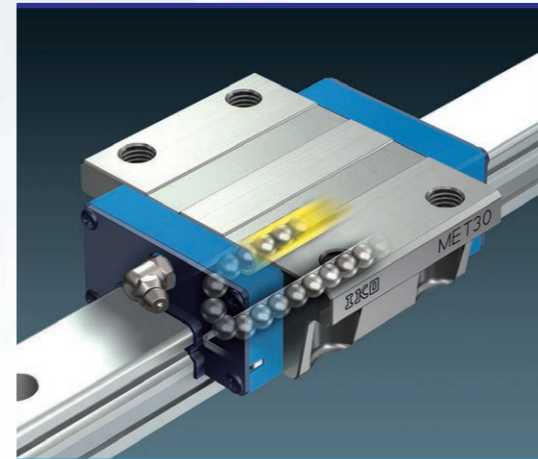

Ball Type Compact Series

C-Lube Linear Way ME Linear Way E Low Decibel Linear Way E

Versatile linear motion rolling guide that has achieved utility pursuing compactness in every aspect. Low decibel types with resin separator to prevent direct contact between balls are also available.

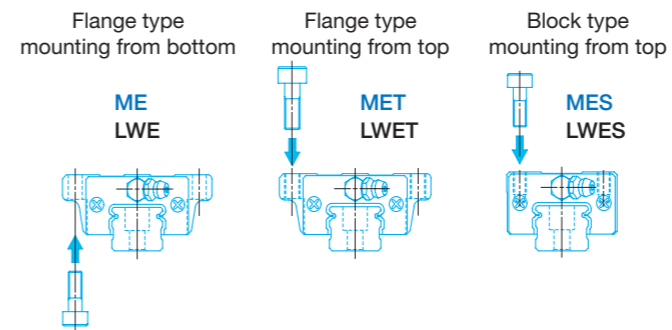

Length of slide unit		Size
C	Short	15, 20, 25, 30, 35, 45
No symbol	Standard	
G	Long	

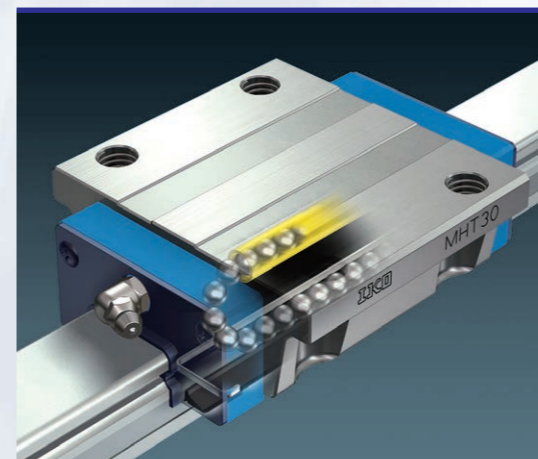

Ball Type High Rigidity Series

C-Lube Linear Way MH Linear Way H

High rigidity linear motion rolling guides designed to evenly support high load capacity by incorporating large-diameter balls. Stable accuracy and rigidity can be achieved even in applications where load with variable direction and size and complex load are applied.

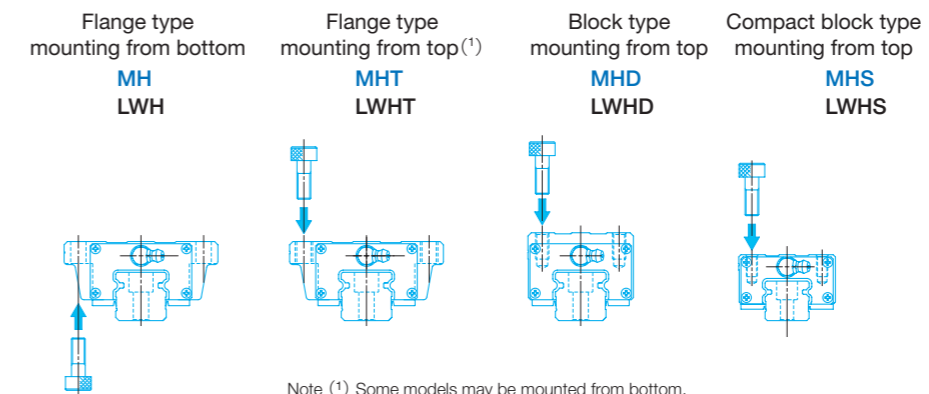

Length of slide unit	
C	Short
No symbol	Standard
G	Long

Note (1) Some models may be mounted from bottom.

Size
8, 10, 12, 15, 20, 25, 30, 35, 45, 55, 65

A variety of models and size variations

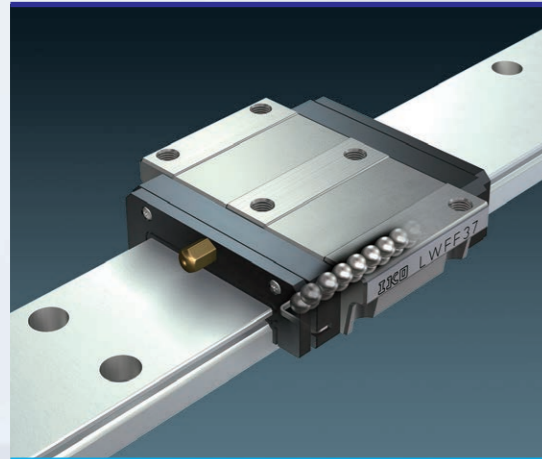

Ball Type Wide Type Series

Linear Way F

As wide track rail is used and the distance between the load points is long, this is a linear motion rolling guide suitable to single-row use due to the structure resistant to across-the-width moment load. It is also resistant to complex load.

Flange type mounting from top / bottom
LWFH

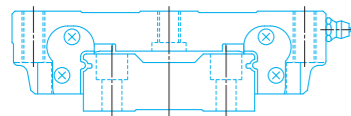

Flange type mounting from top / bottom
LWFF

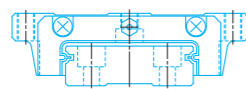

Block type mounting from top
LWFS

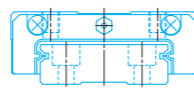

Length of slide unit	
No symbol	Standard
Size	
LWFH	40,60,90
LWFF	33,37,42,69
LWFS	33,37,42

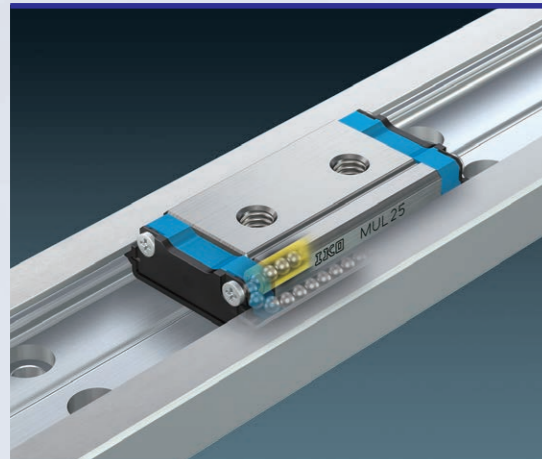

Ball Type U-Shaped Track Rail Series

**C-Lube Linear Way MUL
Linear Way U**

Linear motion rolling guide of the structure with way inside the track rail of U-shaped section and slide unit therein. With the U-shaped track rail, rigidity against the track rail moment load and torsion is significantly improved.

Small type
MUL

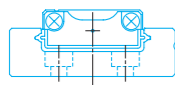

Standard type
LWU

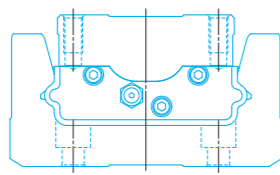

Length of slide unit	
No symbol	Standard
Size	
MUL	25, 30
LWU	40, 50, 60, 86

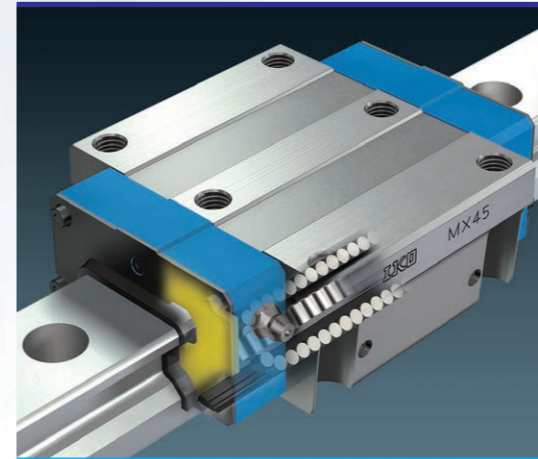

Roller Type

**C-Lube Linear Roller Way Super MX
Linear Roller Way Super X**

Linear motion rolling guide that has achieved the highest level of performance in all characteristics utilizing the roller's superior characteristic, such as rigidity, load capacity, running accuracy and vibration damping property. With extra long unit with the maximum slide unit length, load capacity and rigidity are improved and running performance with super high accuracy is realized.

Flange type mounting from top / bottom
MX⁽¹⁾
LRX⁽¹⁾

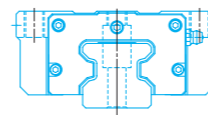

Block type mounting from top
MXD
LRXD

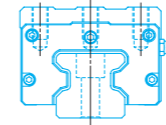

Compact block type mounting from top
MXS
LRXS

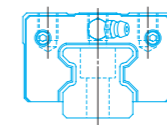

Low profile flange type mounting from top
MXN

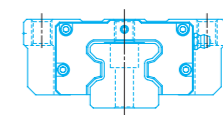

Low profile block type mounting from top
MXNS

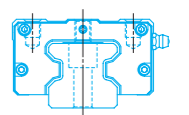

Note (1) Size 20 series allows only for mounting from top and model mounting from bottom is MXH and LRXH.

Length of slide unit			
C	No symbol	G	L
Short	Standard	Long	Extra long

Size
10, 12, 15, 20, 25, 30, 35, 45, 55, 65, 85, 100

**Four-row roller guide of world's smallest size
Track rail width of 10 mm**

Super high rigidity
Super high load capacity
High running performance
Excellent frictional characteristics

Stainless steel made
LRXD10...SL

Features of extra long unit

C-Lube Linear Roller Way Super MX

Length of slide unit is **1.4 to 1.5 times longer** than that of standard unit

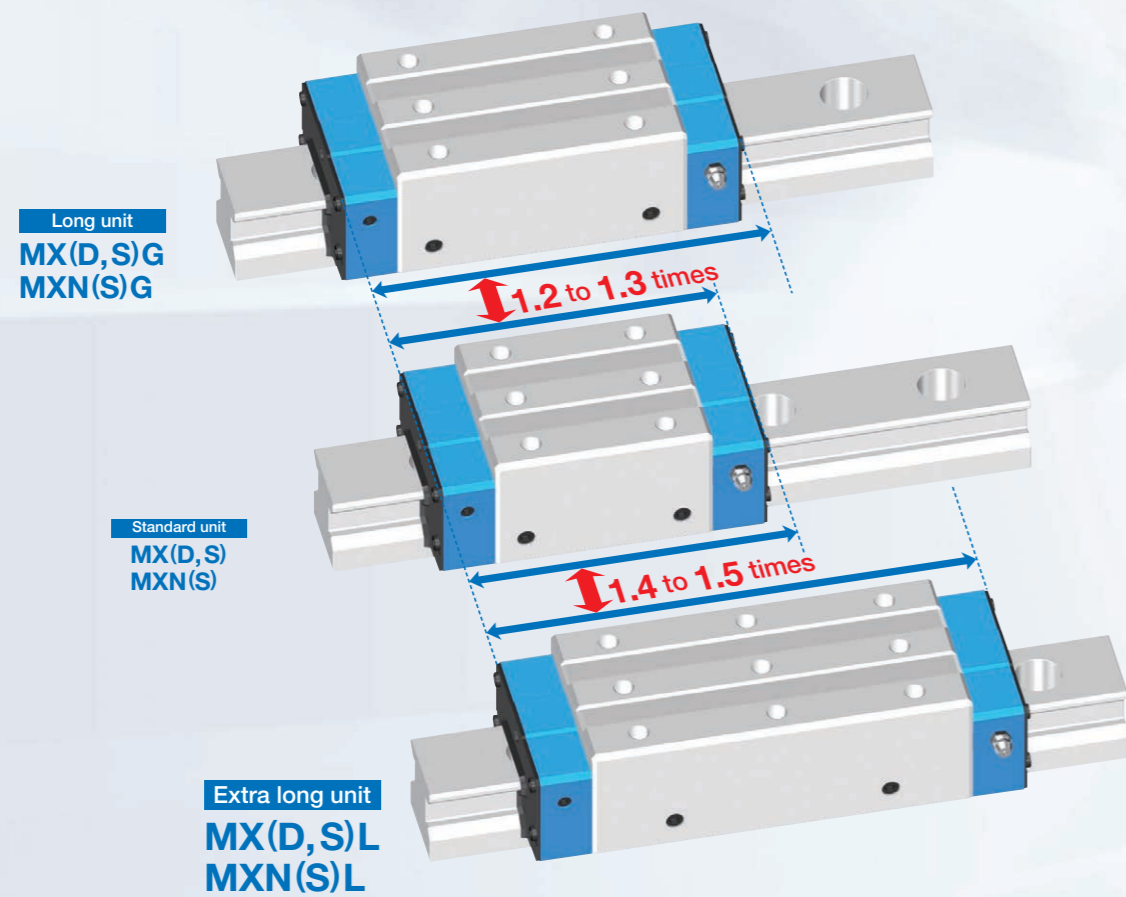

Super accurate feeding mechanism is realized

As running accuracy is as low as a half of that of long unit, feeding mechanism with super high accuracy can be realized.

Test conditions

Test portion	Extra long unit
Preload	T ₃ preload

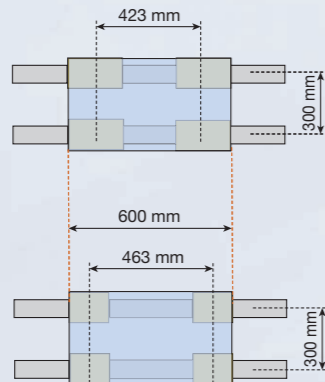

Test conditions

Test portion	Long unit
Preload	T ₃ preload

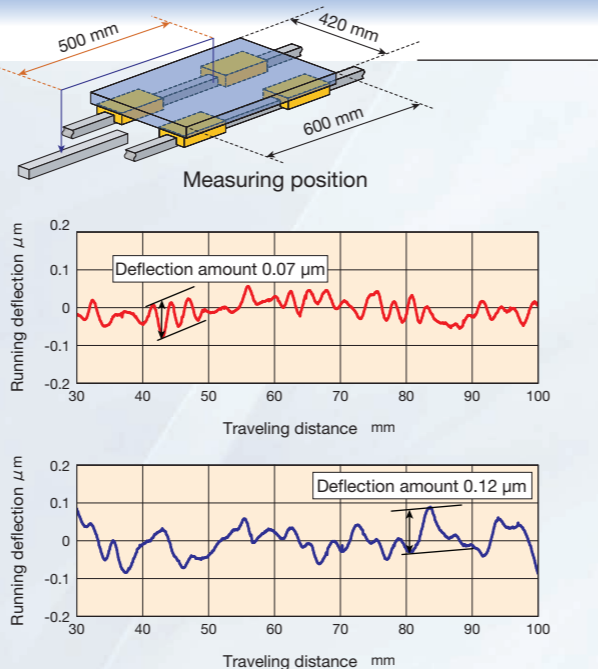

High accuracy running performance is realized without major change of machine or device design⁽¹⁾!

Note (1) Position of the slide unit mounting hole is changed.

Further improvement of running accuracy

Load capacity and rigidity are significantly improved!!

Load capacity of machine or device is improved

As its basic dynamic load rating and basic static load rating are larger than those of Long type by 122% and 129%, respectively, life and margin safety of machine or device are improved.

Comparison of basic dynamic load rating

Increased to **158%** relative to standard unit!
Increased to **122%** relative to long unit!

(In case of MXL45)

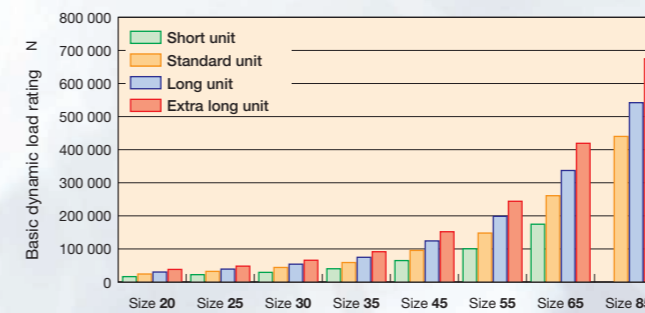

Comparison of basic static load rating

Increased to **181%** relative to standard unit!
Increased to **129%** relative to long unit!

(In case of MXL45)

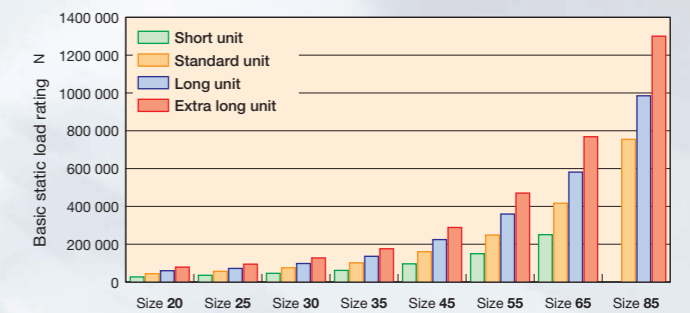

Contributing to improvement of machine or device rigidity

Elastic deformation relative to load is small in comparison with long unit, device rigidity is improved, accuracy is improved, and resonance can be avoided.

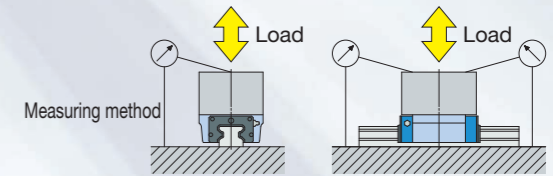

Comparison of elastic deformation under downward load

Rigidity increased to **155%** relative to standard unit!
Rigidity increased to **117%** relative to long unit!

(With displacement of 10 μm for Size 45)

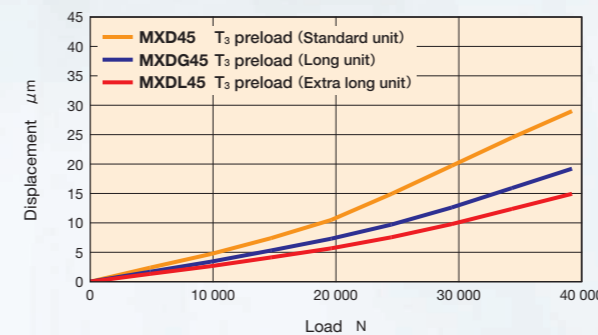

Comparison of elastic deformation under upward load

Rigidity increased to **152%** relative to standard unit!
Rigidity increased to **113%** relative to long unit!

(With displacement of 10 μm for Size 45)

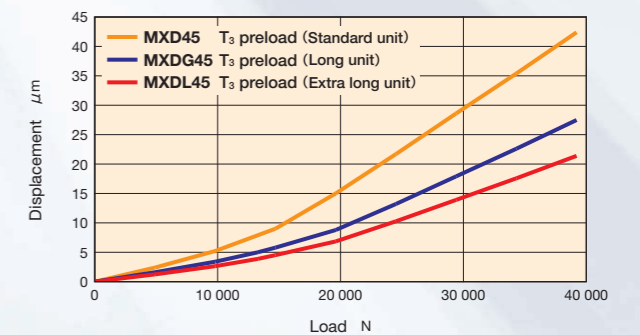

1N=0.102kgf=0.2248lbs.
1mm=0.03937inch

C-Lube Linear Roller Way Super MX

MX MASTER GRADE

Introducing the low fluctuation specification product, for superb high-precision feed!

The C-Lube Linear Roller Way Super MX low fluctuation specification MX Master Grade has special precision processing on the roller raceway surface, significantly reducing fluctuation compared to the standard extra long unit and thus making it the ideal product for ultra-precision working machine shaft guides, which require high-precision, high-quality machining.



Applicable products

Series	C-Lube Linear Roller Way Super MX
Supported models	MXL, MXDL, MXSL, MXNL, MXNSL
Size	30·35·45·55

MX Master Grade (low fluctuation specifications) is a special order product; if needed please contact IKO.

Features

1 Special raceway processing suppresses miniscule running deflection and significantly reduces pulsation compared to standard extra long units.

Fluctuation comparison data

Pulsation: Refers to the running deflection related to movement of the rolling elements within the Linear Roller Way.

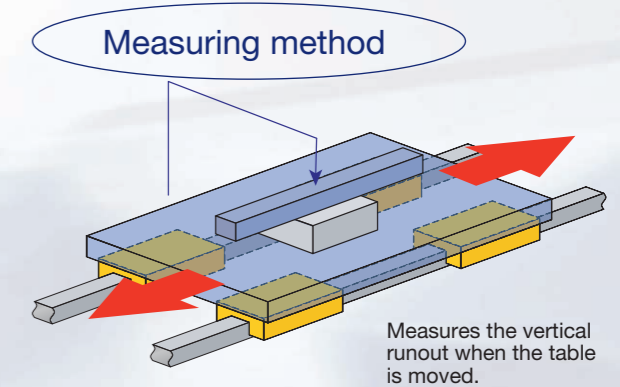
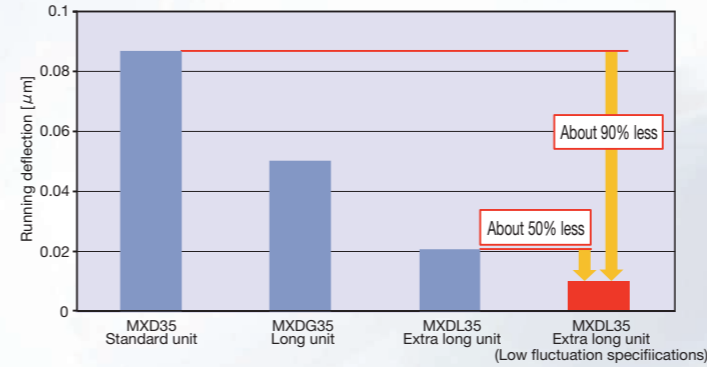

Super low fluctuation is achieved!
About 50% less fluctuation compared with the standard extra long unit!

2 Low fluctuation makes it ideal for ultra-precision working machine shaft guides, which require high-precision, high-quality machining.

Fluctuation data

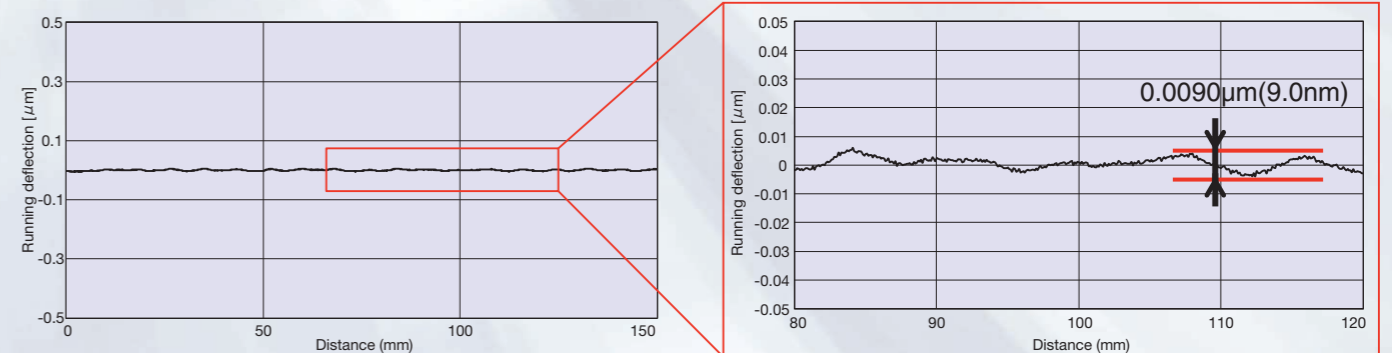

The **running deflection value** is within **0.0090µm(9.0nm)** in actual measurement!
 Improve machining quality with the use of MX Master Grade!

3 The extra long unit contributes to improved load capacity and rigidity in mechanical equipment.

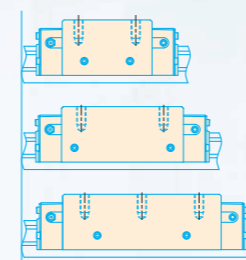

Standard

Long

Extra long

Elastic deformation relative to load is low in comparison with the standard and long types, device rigidity is improved, accuracy is improved, and resonance can be avoided.